



---

DESIGN GUIDE  
ICBOG Series Outdoor  
Grills

## TABLE OF CONTENTS

---

3	OUTDOOR GRILLS   MODULES
---	--------------------------



Features and specifications are subject to change at any time without notice.

Throughout this guide, dimensions may vary by  $\pm 3$  mm.

## Outdoor Grills and Modules

Taste what happens when the heritage of professional cooking moves from the kitchen to the patio. Like their indoor counterparts, Wolf outdoor grills are precision instruments. Constructed of heavy-duty stainless steel, the 76 cm, 91 cm, 107 cm, and 137 cm grills have powerful burners every 130mm for even heat distribution. An electric rotisserie with infrared burner produces succulent poultry and roasts. Wolf grills and modules can be ordered in natural or LP gas.

### OUTDOOR GRILLS

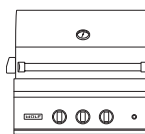

ICBOG30

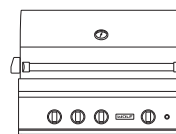

ICBOG36

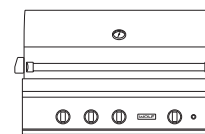

ICBOG42

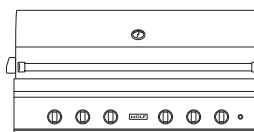

ICBOG54

### OUTDOOR MODULES



ICBBM13  
BURNER MODULE

Outdoor Grills and Modules

OUTDOOR GRILL

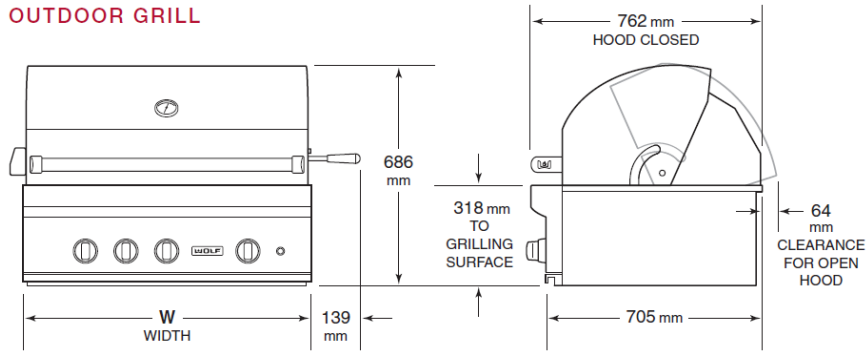

BURNER MODULE

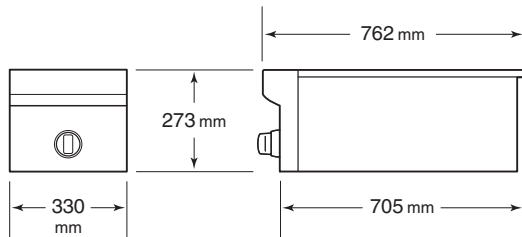

ICBBM13

OUTDOOR GRILL

W

ICBOG30	762 mm
ICBOG36	914 mm
ICBOG42	1067 mm
ICBOG54	1372 mm

## Outdoor Grills and Modules

### BURNER RATING

GRILL BURNERS	Mj/h
ICBOG30, ICBOG36, ICBOG42, ICBOG54	29

SEAR ZONE	Mj/h
ICBOG36, ICBOG42	29
ICBOG54	29

ROTISSERIE	Mj/h
ICBOG30, ICBOG36,	15
ICBOG42	17
ICBOG54	(2) 15
ICBBM13	25

## Planning Information

For built-in applications, Wolf outdoor grills and the burner module are designed for easy placement into a built-in enclosure. For outdoor grills, installation in a combustible enclosure requires an insulating liner. For the burner module, an insulating liner is not required. The enclosure should be built according to specifications for your specific installation on the following pages. **If the burner module is installed next to an outdoor grill, a minimum of 305 mm is required between the units on the rotisserie motor side and 51 mm on the opposite side.** A rotisserie side conversion kit is available from an authorized Wolf dealer.

Insulating liners are available through an authorized Wolf dealer.

## Planning Information

### ELECTRICAL REQUIREMENTS

Installation must comply with all applicable electrical codes and be properly grounded (earthed).

The electrical outlet must be located within reach of the power cord.

### ELECTRICAL REQUIREMENTS (GRILL / MODULE)

Electrical Supply	grounded, 220-240 VAC, 50/60 Hz
Service	1 A
Receptacle	3-prong grounding-type (earthed), IEC inlet

### ELECTRICAL REQUIREMENTS (ROTISSERIE)

Electrical Supply—Input	grounded, 220-240 VAC, 50/60 Hz
Electrical Supply—Output	12 VDC
Service	0.5 A (6 Watts)

### GAS SUPPLY

Installation must conform with all applicable gas codes.

A gas supply line of 19 mm rigid pipe is recommended to the outdoor grill or module. If local codes permit, a certified, .9 m long, 13 mm or 19 mm ID flexible appliance connector is recommended to connect the units

An inline regulator is installed on the unit for connecting to NAT or LP gas sources.

### GAS REQUIREMENTS

#### NATURAL GAS

Regulator Pressure	1 kpa
--------------------	-------

#### LP GAS

Regulator Pressure	2.75 kpa
--------------------	----------

Outdoor Grill

NON-COMBUSTIBLE INSTALLATION

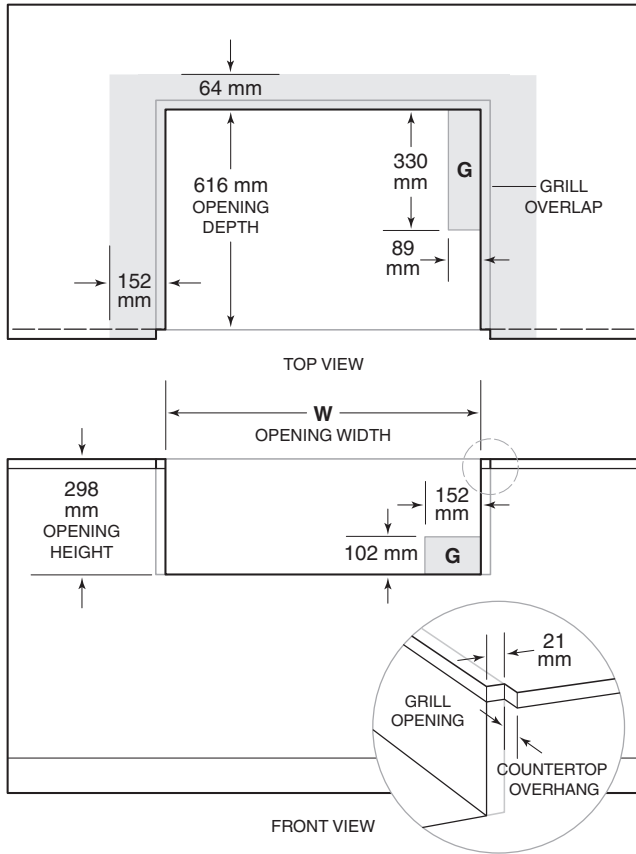

NOTE: Shaded area above countertop indicates minimum clearance to combustible surfaces, combustible materials cannot be located within this area.

COMBUSTIBLE SURFACE INSTALLATION

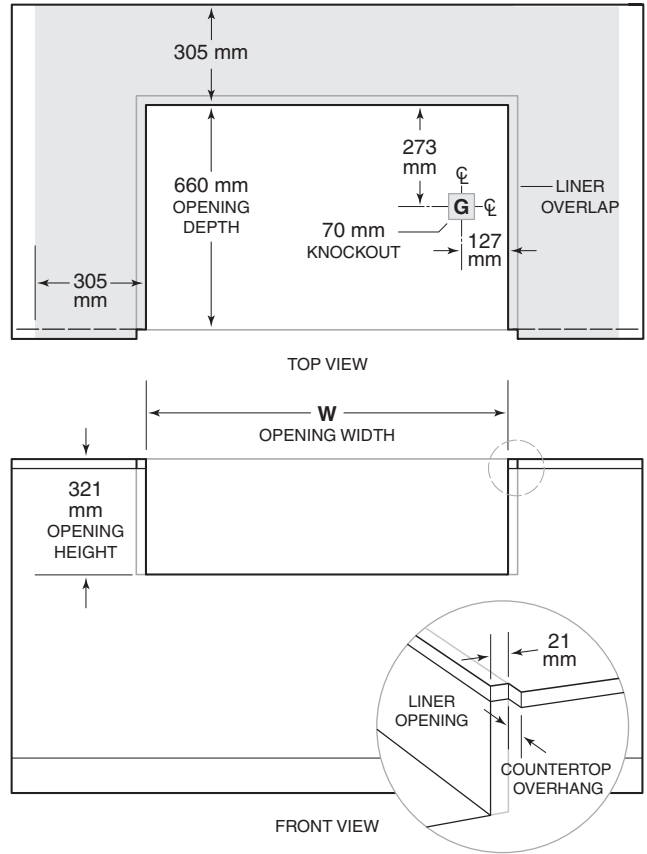

NOTE: Shaded area above countertop indicates minimum clearance to combustible surfaces, combustible materials cannot be located within this area.

NON-COMBUSTIBLE ENCLOSURE	W
ICBOG30	724 mm
ICBOG36	876 mm
ICBOG42	1029 mm
ICBOG54	1334 mm

COMBUSTIBLE ENCLOSURE	W
ICBOG30	851 mm
ICBOG36	1003 mm
ICBOG42	1156 mm
ICBOG54	1461 mm

## Burner Module

### INSTALLATION

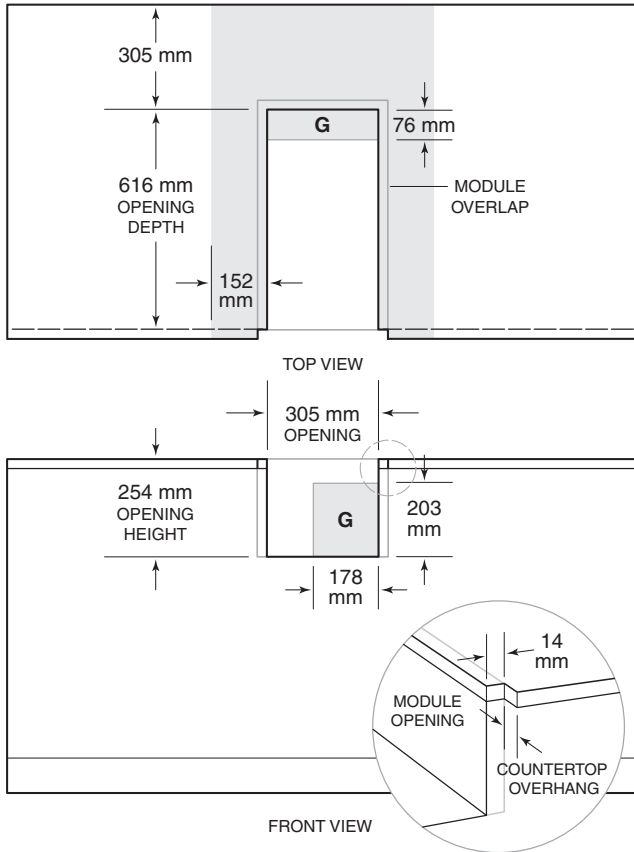

*NOTE: Shaded area above counter top indicates minimum clearance to combustible surfaces, combustible materials cannot be located within this area. An insulating liner is not required for the ICBBM13.*

ICBBM13



## Wolf Appliance International Limited Warranty

### FOR RESIDENTIAL USE

These Warranty Terms and Conditions ('Warranty') constitute your agreement with Sub-Zero Group Australia Pty Ltd (ACN 610 807 899) ('Wolf') and will apply to your service order. The benefits given by this Warranty are in addition to all consumer guarantees and other rights and remedies prescribed by the Australian Consumer Law and any other applicable laws.

Our products come with guarantees that cannot be excluded under the Australian Consumer Law. You are entitled to a replacement or refund for a major failure and compensation for any other reasonably foreseeable loss or damage. You are also entitled to have the goods repaired or replaced if the goods fail to be of acceptable quality and the failure does not amount to a major failure.

In addition to your rights and remedies under the Australian Consumer Law, Wolf provides customers with a Warranty where, if any part of a Wolf product is found upon inspection by an authorised Wolf representative or an associated licensed technician supplied by either Wolf or a relevant approved supplier (including a Wolf factory certified service) ('Service Representative') to be defective in materials or workmanship, Wolf will repair and replace the part as follows:

#### FULL TWO YEAR WARRANTY\* (\*\*Outdoor product full one year warranty)

For two years from the date of original installation, this Wolf Appliance product warranty covers all parts and labour to repair or replace, under normal residential use, any part of the product that proves to be defective in materials or workmanship. All service provided by Wolf Appliance under the above warranty must be performed by Wolf factory certified service, unless otherwise specified by Wolf Appliance, Inc. Where the Service Representative is unable to identify any fault in the product, Wolf may require the consumer to provide proof that the product is defective. For the avoidance of doubt, defective products or parts become Wolf's property. Service will be provided during normal business hours.

#### LIMITED FIVE YEAR WARRANTY

For five years from the date of original installation, Wolf Appliance will repair or replace the following parts that prove to be defective in materials or workmanship: gas burners (excludes appearance), electric heating elements, blower motors (ventilation hoods), electronic control boards, magnetron tubes and induction generators. If the owner uses Wolf factory certified service, the service provider will repair or replace the above listed parts at no cost with the owner paying for all other costs, including labour. If the owner uses non-certified service, the owner must contact Sub-Zero Group Australia, (using the information below) to receive repaired or replacement parts. Wolf Appliance will not reimburse the owner for parts purchased from non-certified service or other sources.

#### TERMS APPLICABLE TO EACH WARRANTY

The warranty applies only to products installed for normal residential use. This warranty does not cover any parts or labour to correct any defect caused by negligence, accident or improper use, maintenance, installation, service or repair.

#### CLAIM PROCEDURE

In order to claim the Warranty, you must cease using the product when a fault arises, contact Sub-Zero or authorised Sub-Zero dealer where the product was purchased to report the issue and follow Sub-Zero's directions regarding what to do next. Sub-Zero's general contact details are as follows:

Sub-Zero Group Australia

11-19 Bank Place

Melbourne VIC 3000

Phone: 03 9600 2218 email: serviceAU@subzero.com

#### EXCLUSIONS

Except to the extent required by law, all consumer guarantees, representations, warranties, terms and conditions in relation to the products (whether implied or otherwise) are hereby excluded to the maximum extent permitted by law.

To the fullest extent permitted by law, Wolf excludes all liability for damage or injury to any person, damage to any property and any indirect consequential or other loss or damage.

\*Stainless steel (doors, panels, handles, product frames and interior surfaces) are covered by a limited 60-day parts and labour warranty for cosmetic defects.

\*\* Full one year warranty applies to outdoor product. Product must be approved for outdoor use, designated by model and serial number.





[subzero-wolf.com.au](http://subzero-wolf.com.au)