

ICBDEU2450R



FEATURES

Fully customizable exterior, accepting custom panels for an integrated look within cabinetry or stainless steel accessory panels and handles to coordinate with other Sub-Zero and Wolf appliances

Seamlessly integrating anywhere, undercounter refrigeration adds comfort to your master suite, creates a corner for libations in the study, provides subtle storage for delicate cosmetics—the options are endless

Flexible storage options with one stationary and two adjustable shelves

Two on-door shelves easily accommodate a wide variety of condiments and beverages, with ample room for larger two-liter bottles

Intuitive, on-door touch control panel offers ergonomic, convenient access to settings

Cleanup is simple with nano-coated, spill-proof shelf

Clear storage drawer provides quick access to essential items

Offers precise temperature control within one degree of setpoint, preserving dairy, produce, craft beer, and other perishables at their optimal temperature

Soft-on LED lighting fully illuminates the interior when the door is open

ACCESSORIES

Custom Panel Lock Kit

Dual Install Kit - Handle-to-Drawer

Dual Install Kit - Handle-to-Handle

Pro Handle

Stainless Steel Dual Kickplate - 39"

Stainless Steel Dual Kickplate - 48"

Tubular Handle

Stainless Steel Solid Door Panels

Accessories are available through an authorized dealer.
For local dealer information, visit subzero-wolf.com/locator.



HANDLE ACCESSORIES

PRO



TUBULAR



PRODUCT SPECIFICATIONS

Model	ICBDEU2450R
Dimensions	610mmW x 876mmH x 587mmD
Refrigerator Gross Capacity	152 L
Electrical Supply	220-240 VAC; 50/60 Hz
Electrical Service	≤ 2 A
Receptacle	3-prong grounding-type

NOTE: Dimensions in parenthesis are in millimeters unless otherwise specified

INTERIOR VIEW

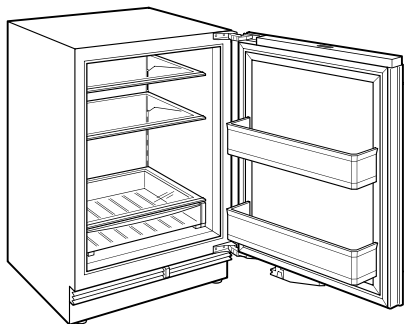

This illustration is intended for interior reference only and may not represent the exterior of the model being specified.

DIMENSIONS

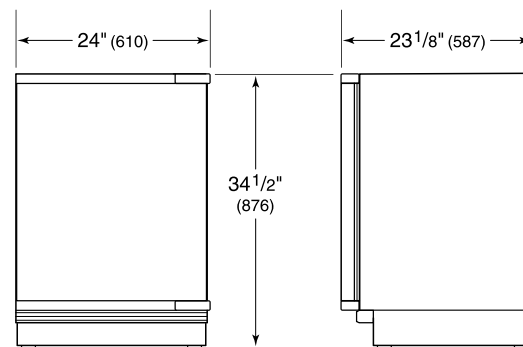

HEIGHT DIMENSIONS ± 1/2" (13)

